

A guide to your Kin Dining Chair →







Life's better together.
Please assemble
with two people.



Kin Dining Chair

Total boxes: 1

BOX 1 : Kin Dining Chair box

QTY	ITEM	
2	Backs	
2	Bases	
8	Hand screws	
8	Rubber washers	

Place the base upside down. We recommend placing the base on a table to help make the assembly easier.

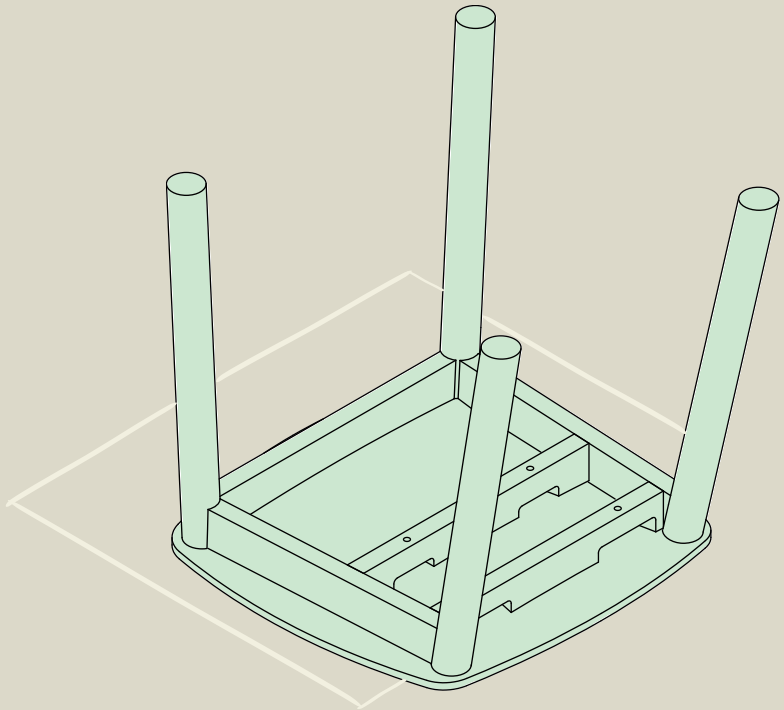

Slide the back into the slots on the base. Then secure them together with 4x washers and 4x handscrews. You can use a 10 cent coin to further tighten the handscrews.

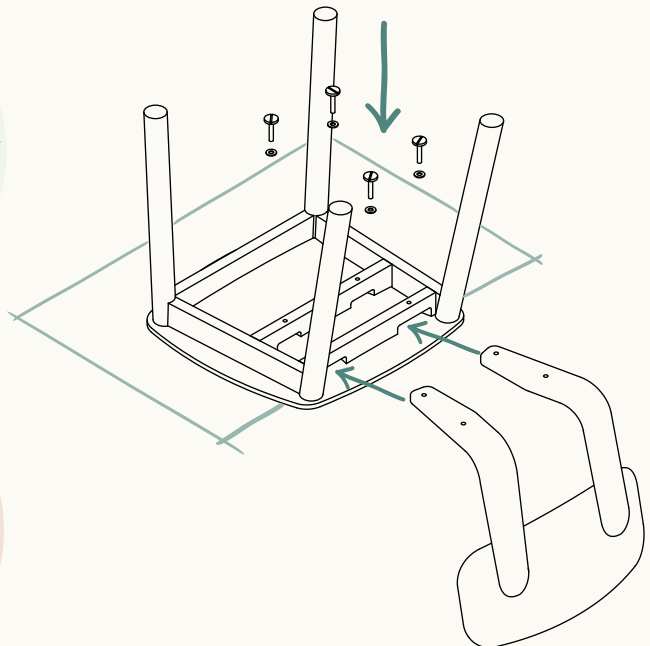
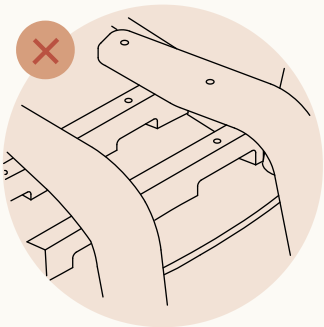
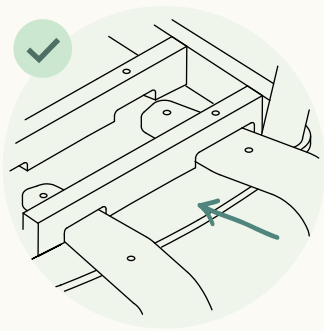

Flip the chair and enjoy!

