



A guide to your Everyday Sofa

Life is better together.
Please assemble with
two people.



What comes with your 6 seater

L-shape

You should have 10 boxes in total.

Low arm seat box - 2 boxes

2x Low arm seats

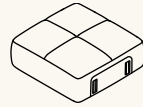

Low arm and back box - 2 boxes

2x Low arms



2x Backs



2x Scatter cushions



What comes with your 6 seater L-shape

Armless seat box - 2 boxes

2x Armless seats

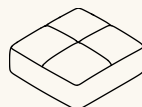

Armless back box - 2 boxes

2x Backs



2x Scatter cushions



What comes with your 6 seater L-shape

High arm / corner seat box - 1 box

1x High arm / corner seat

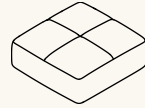

High arm and back box - 1 box

2x Backs



1x Scatter cushion



First, let's assemble the low arm section.

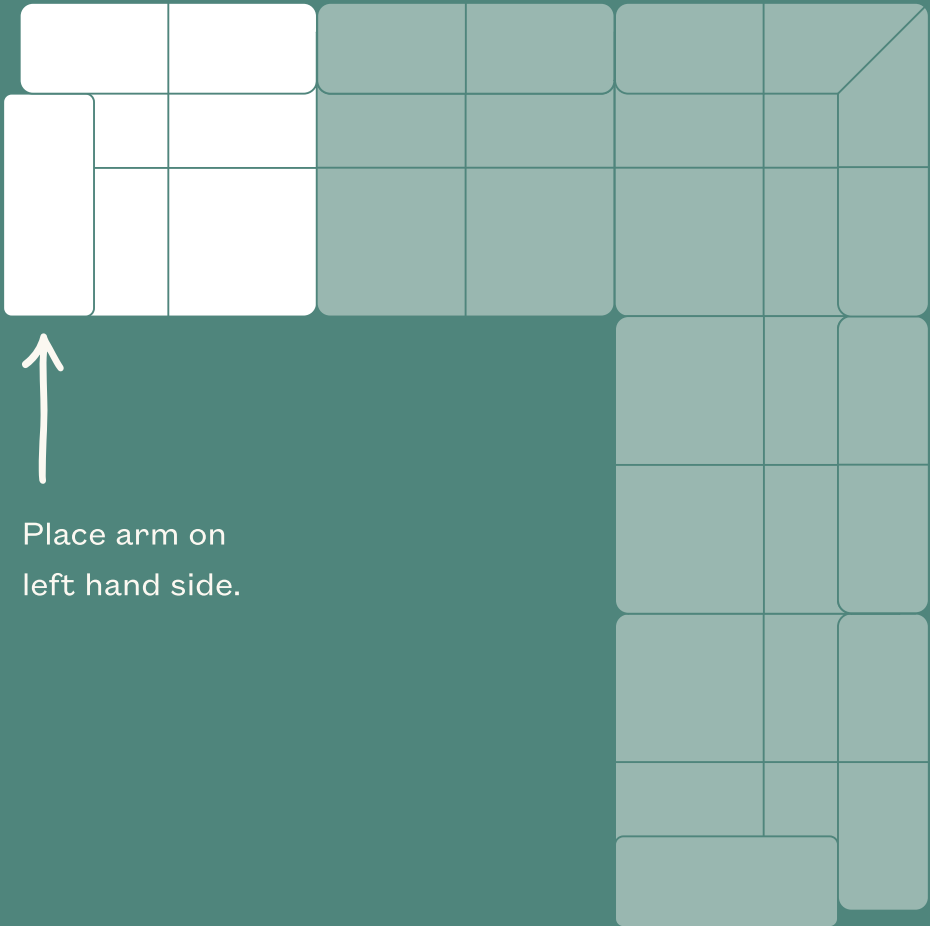

Place arm on
left hand side.

1.

Turn seat up onto its side.

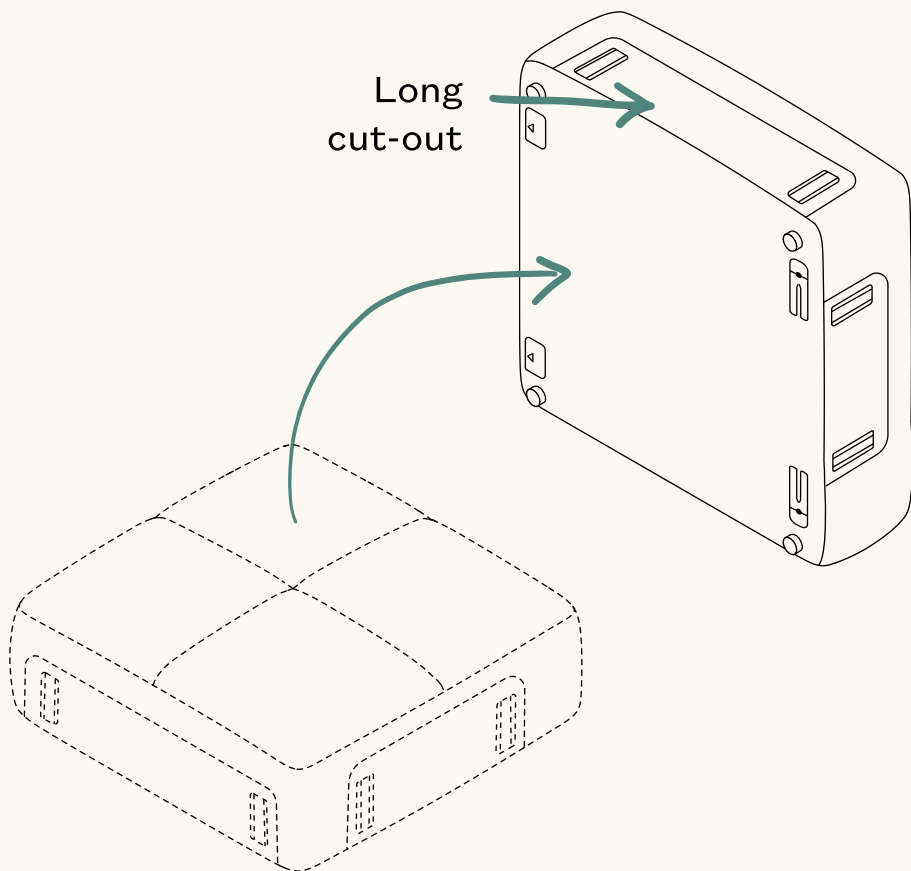

2.

Align brackets between the back and seat and slide back into place.

We recommend having one person slide the back piece on and the other holding the seat in place.

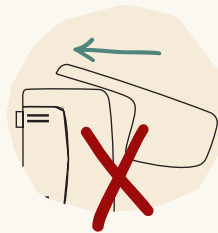
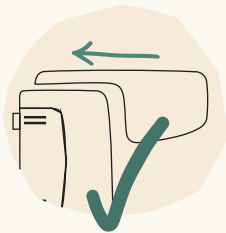
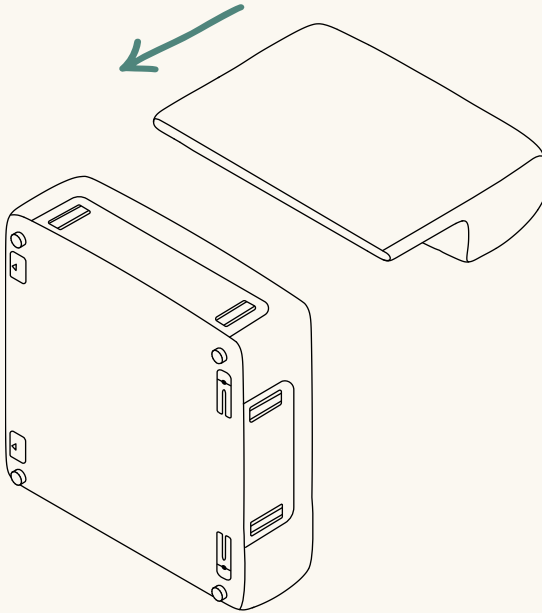

3.

Rotate 90 degrees and flip onto its side.

Arm brackets should be facing the ceiling on the side you would like the arms on.

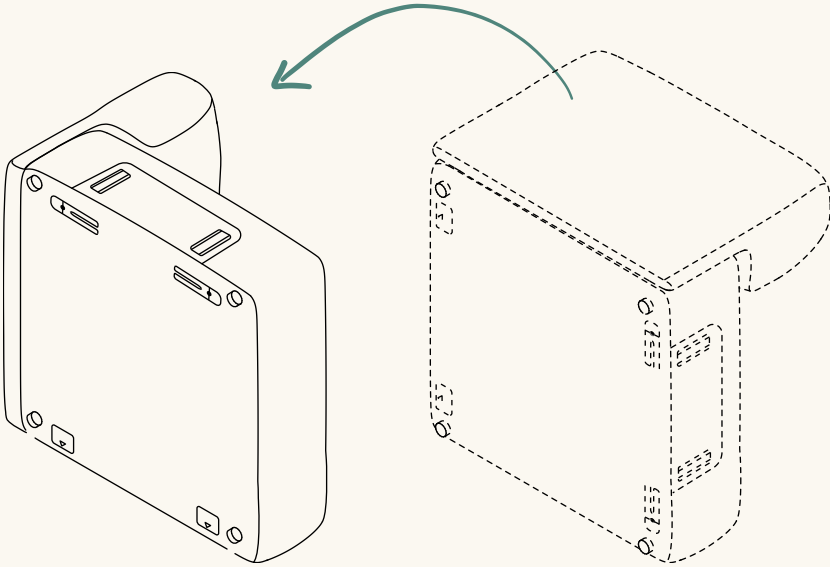

4.

Align brackets between the arm and seat and slide arm into place.

We recommend having one person slide the arm piece on and the other holding the seat in place.

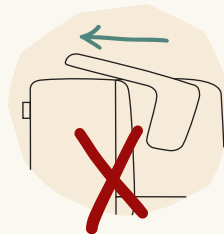
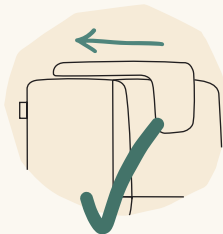
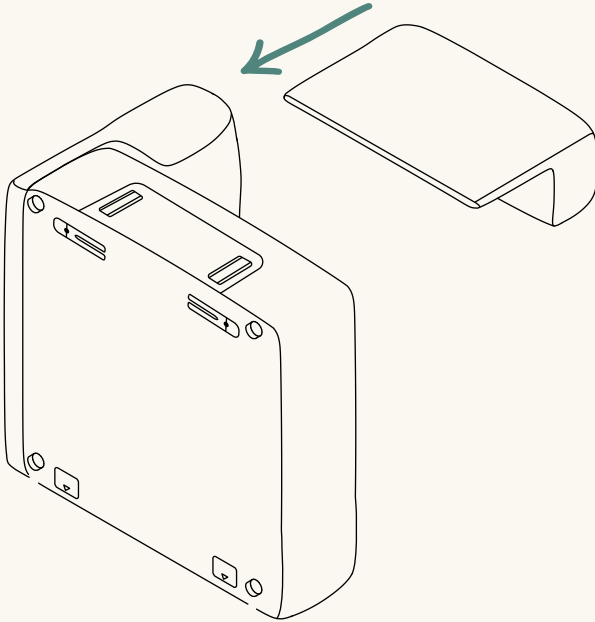

5.

This module is now assembled!
Flip upright and set aside.

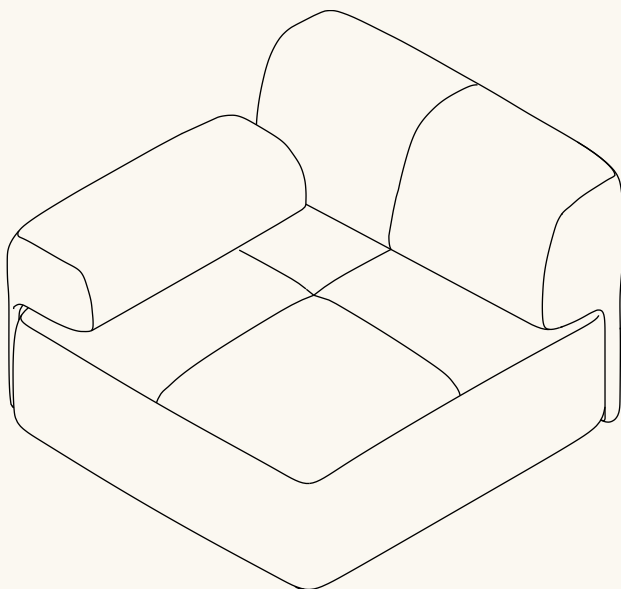

To assemble the right side,
repeat steps 1-4 but place the
low arm on the right side.

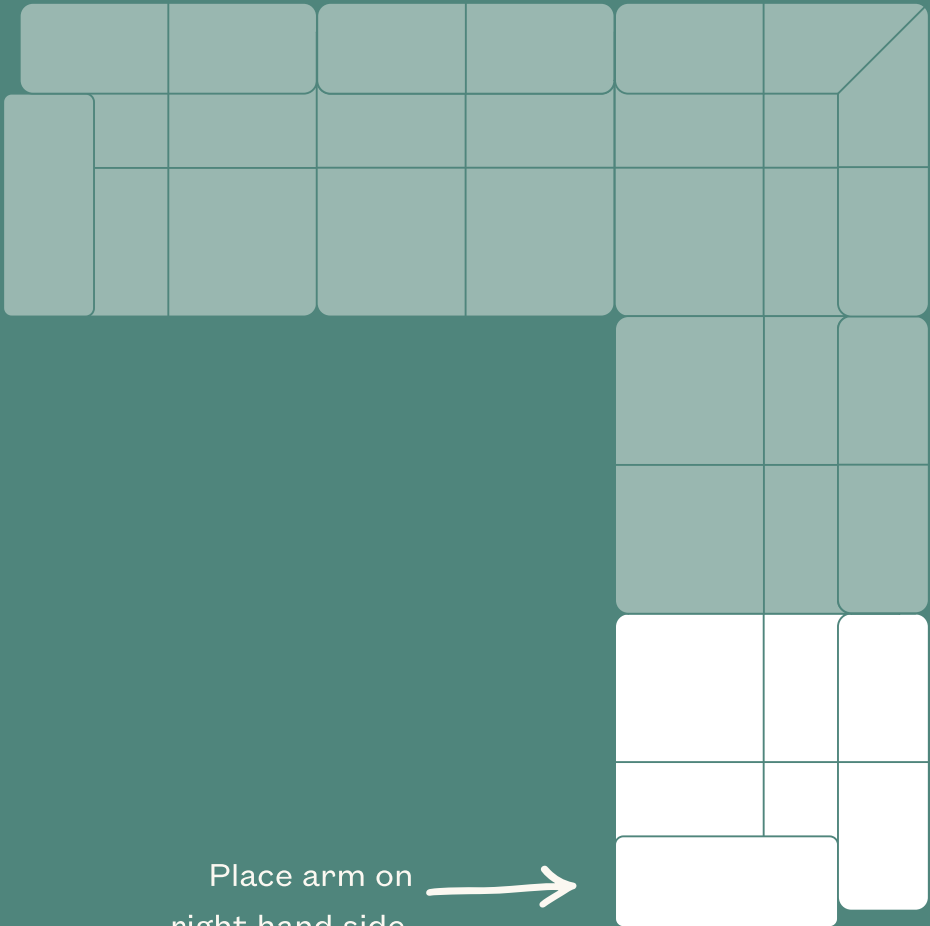

6.

Rotate the brackets out.

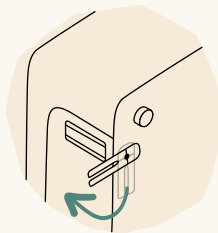
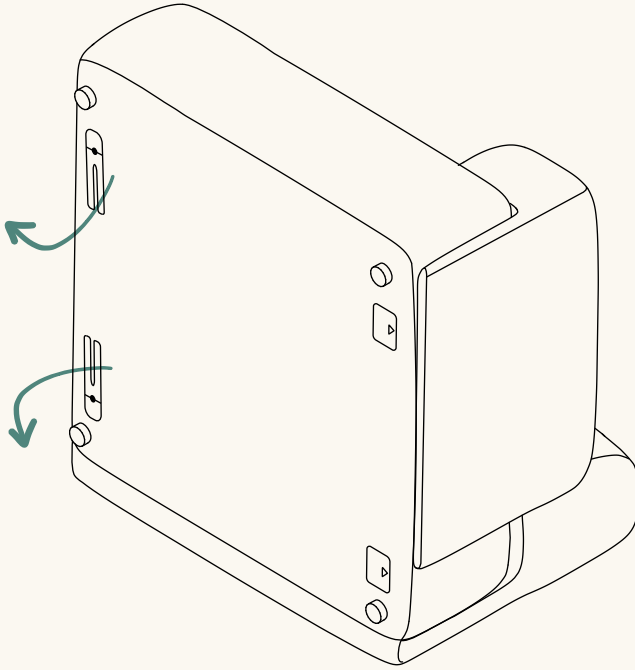

Now let's assemble the middle section.

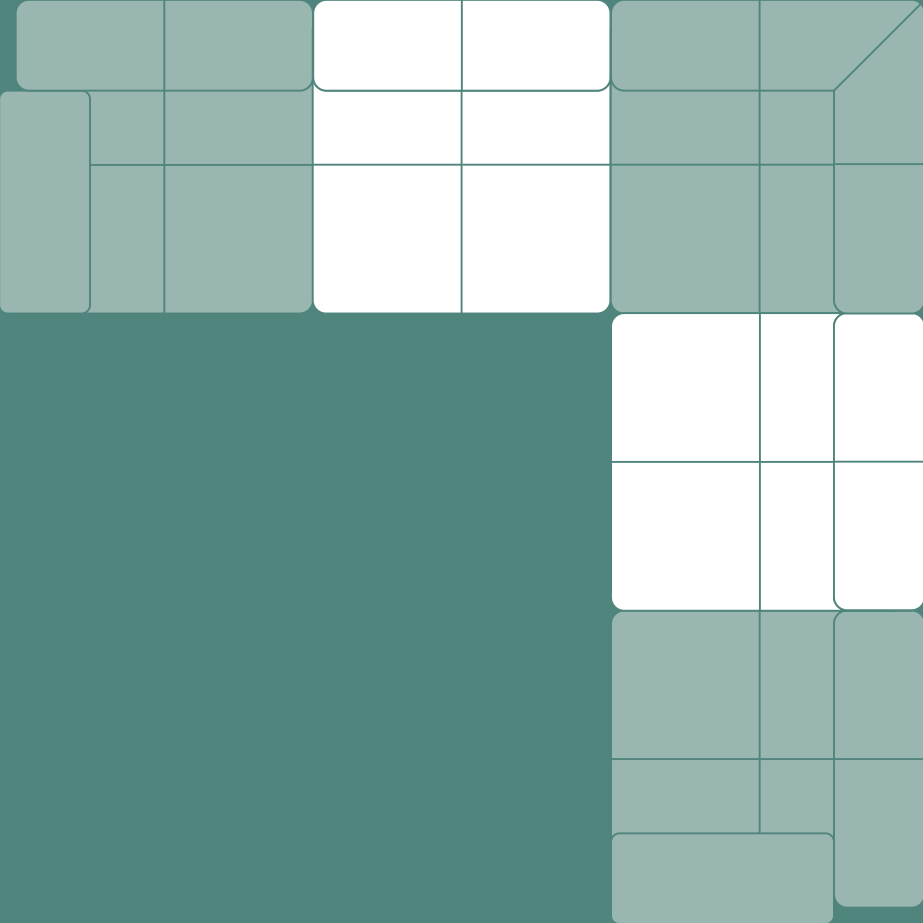

7.

Turn seat up onto its side.

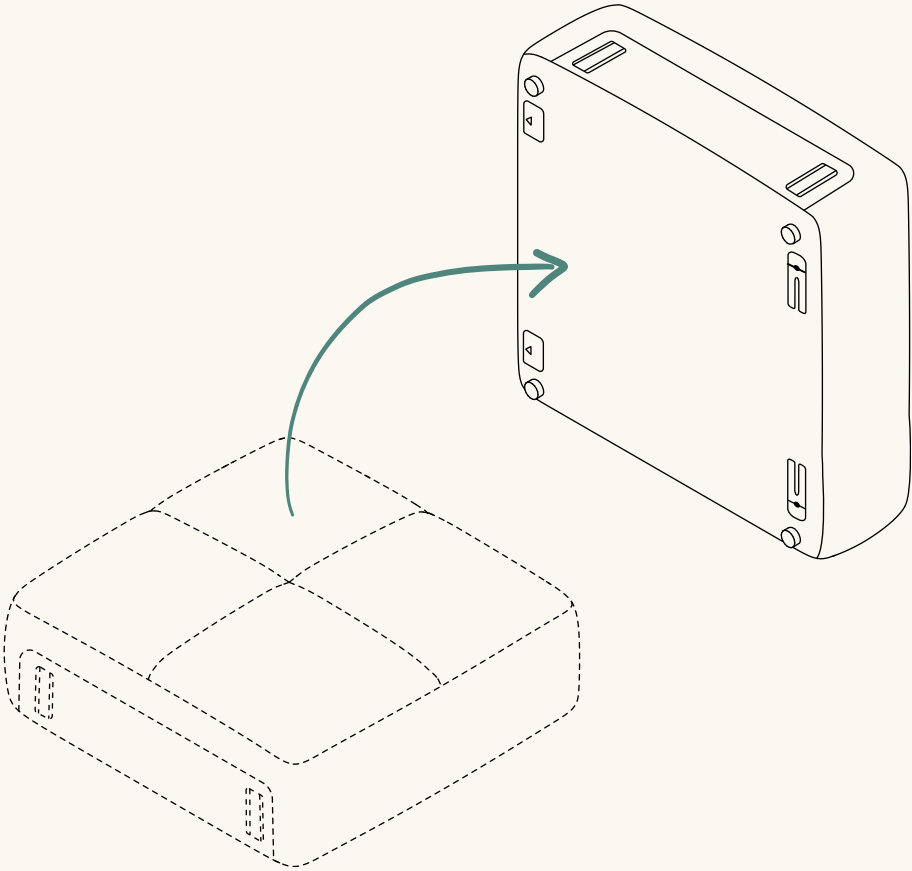

8.

Align brackets between the back and seat and slide back into place.

We recommend having one person slide the arm piece on and the other holding the seat in place.

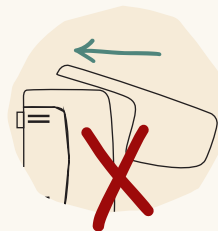
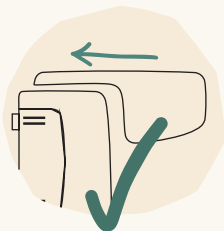
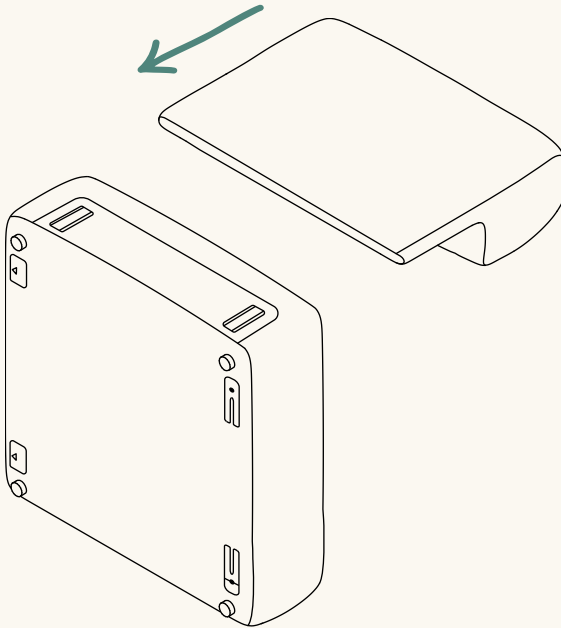

9.

Rotate 90 degrees to your left and rotate the brackets out.

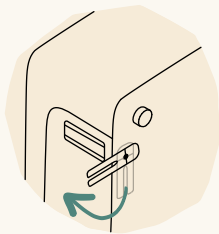
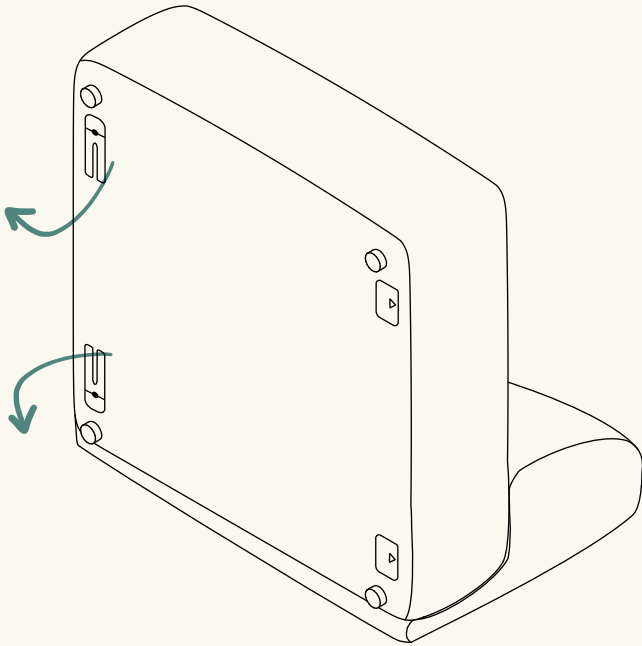

10.

This module is now assembled!
Flip upright and set aside.

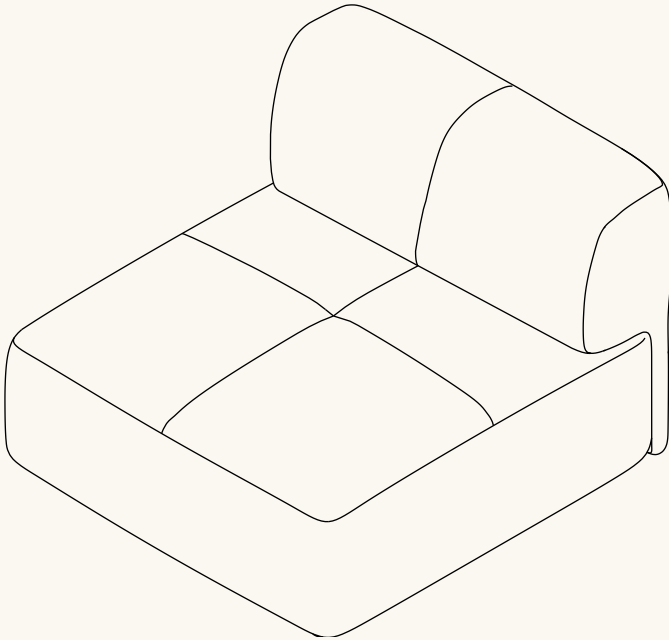

Now let's assemble the corner section.

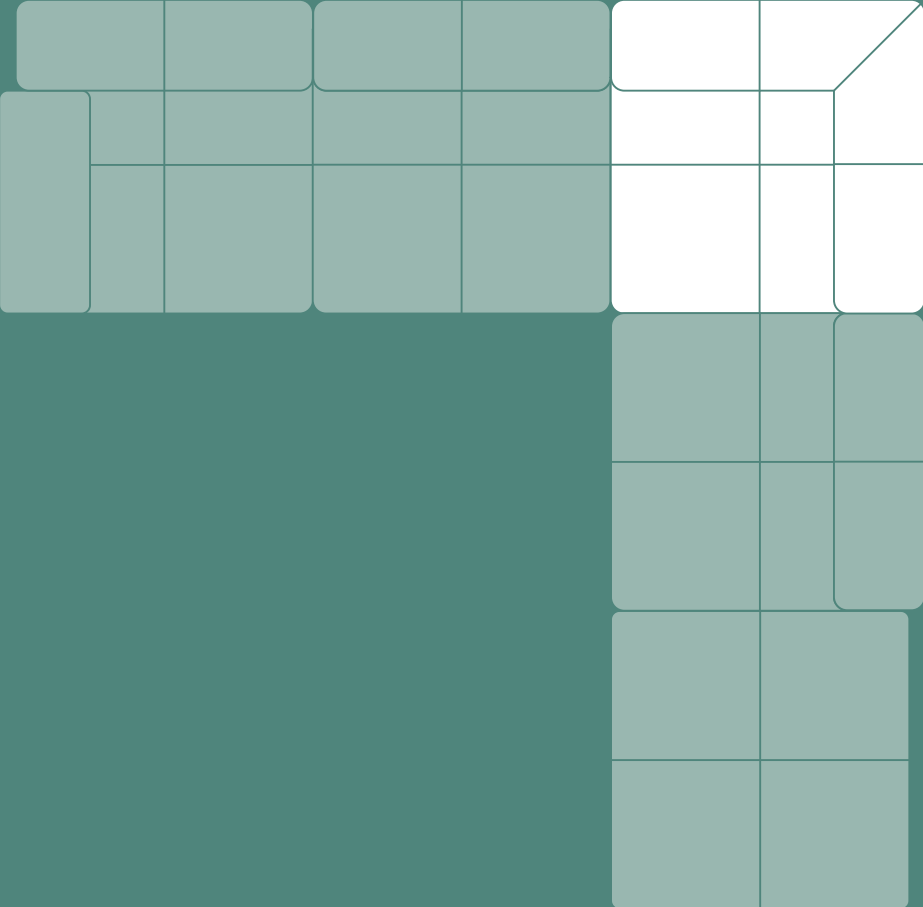

11.

Turn seat up onto its side.

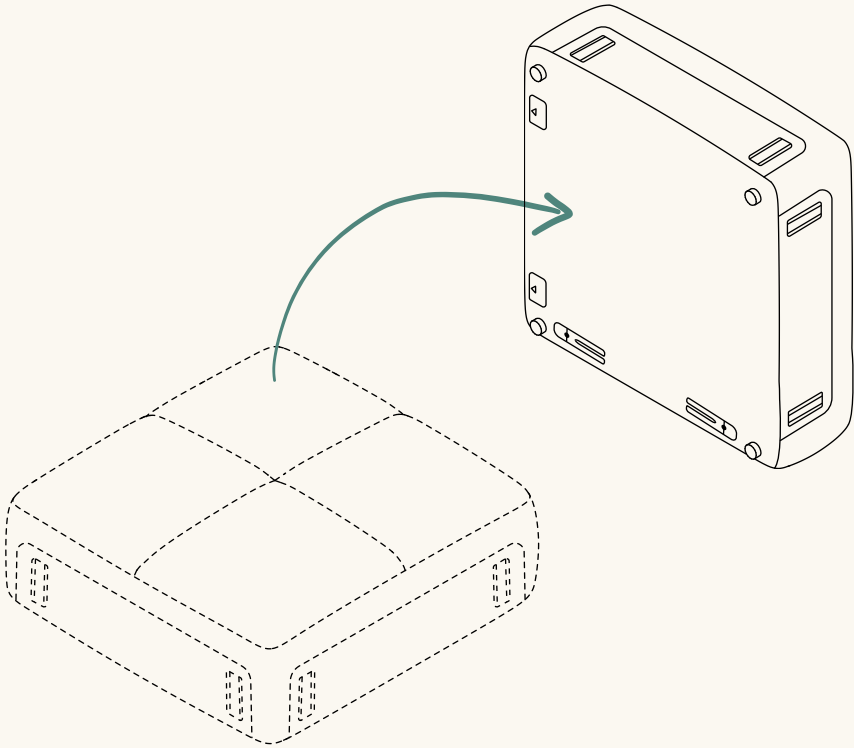

12.

Align brackets between the high arm and seat and slide arm into place.

We recommend having one person slide the high arm piece on and the other holding the seat in place.

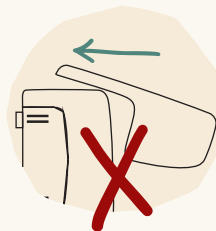
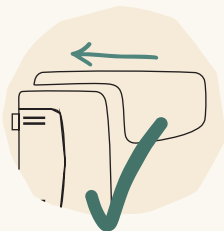
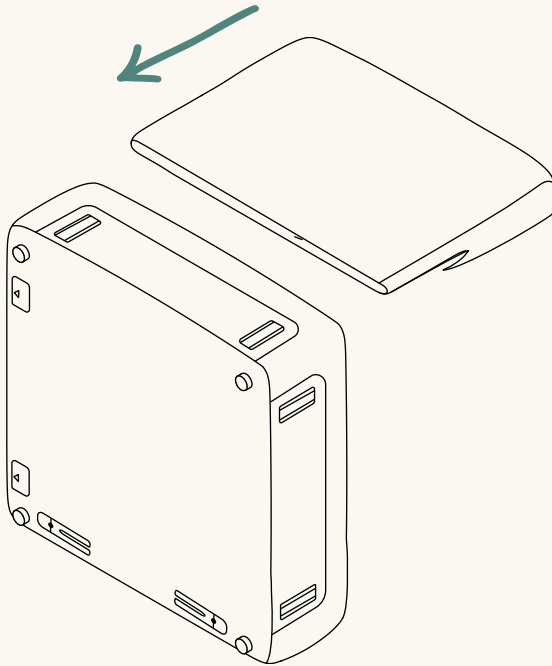

13.

Rotate 90 degrees and flip onto its side.

Brackets should be facing the ceiling.

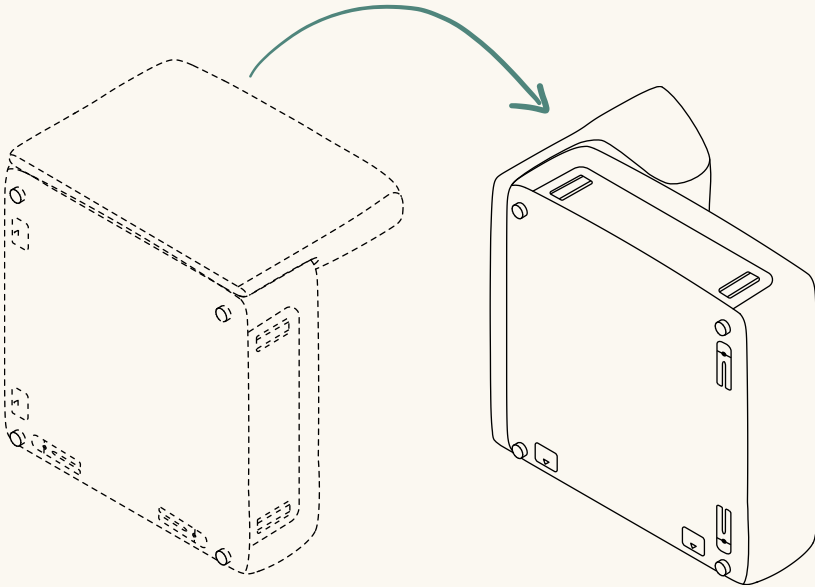

14.

Align brackets between the high arm and seat and slide arm into place.

We recommend having one person slide the high arm piece on and the other holding the seat in place.

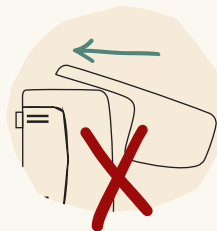
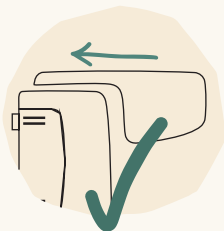
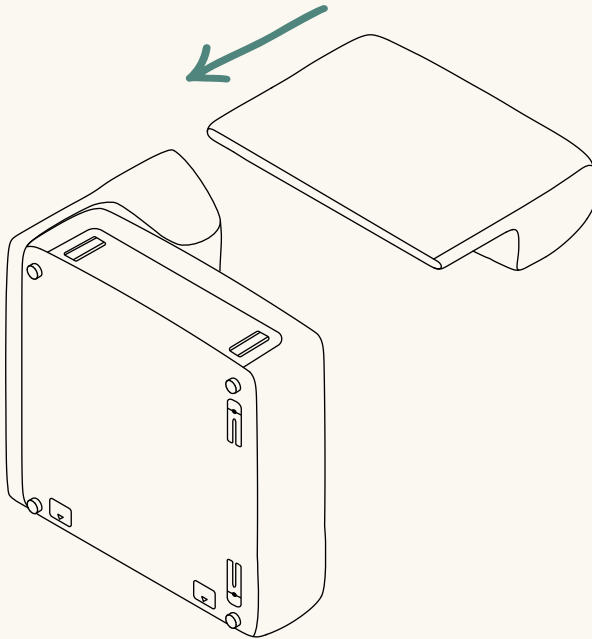

15.

Rotate the brackets out.

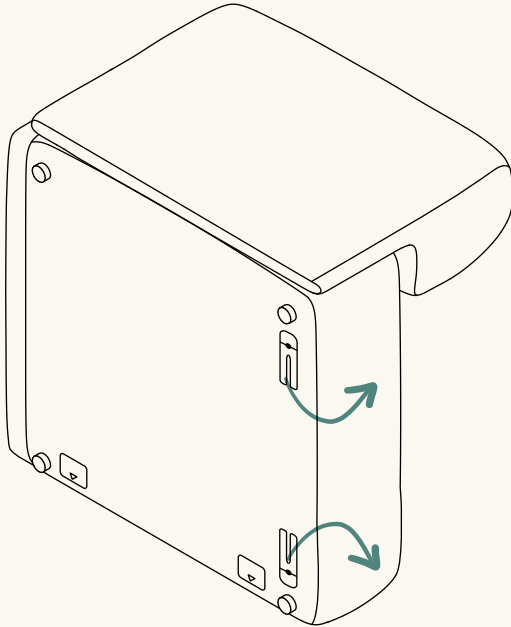

16.

This module is now assembled!
Flip upright and set aside.

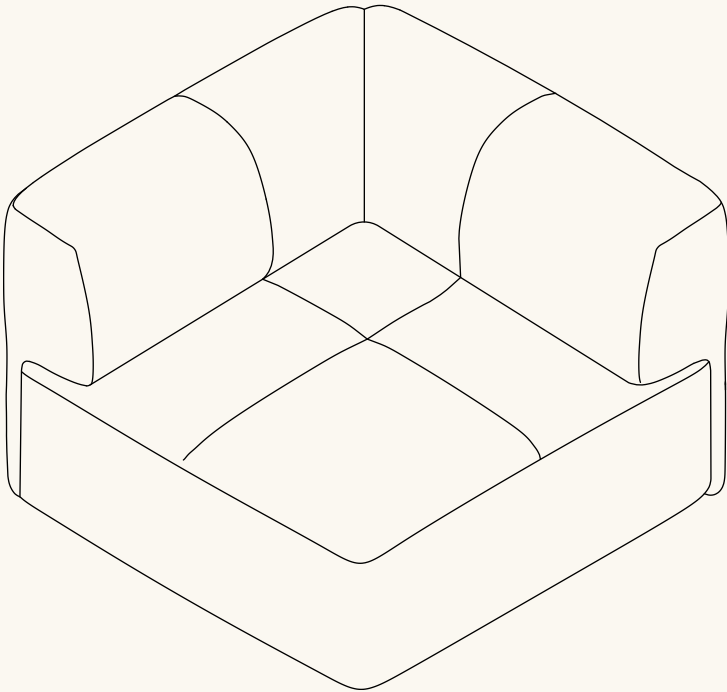

Choose where you would like your Everyday Sofa to live and then it's time to connect the modules together.

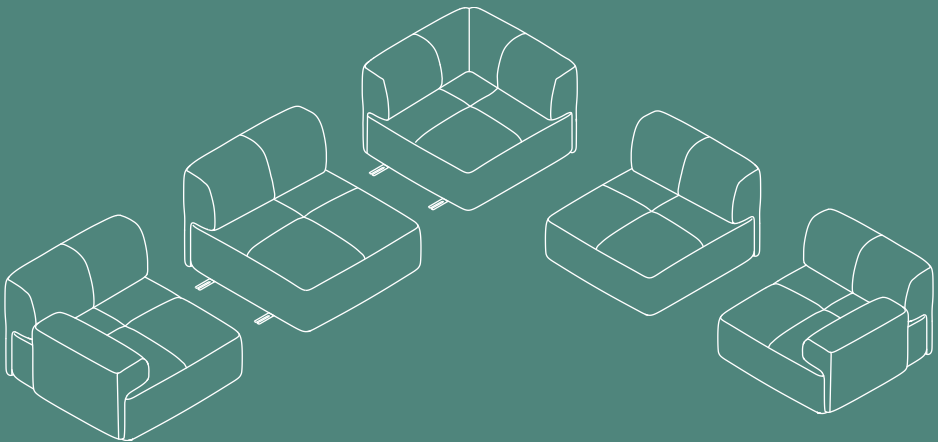

17.

Align connectors and push modules together.

These will click together and lock the pieces.

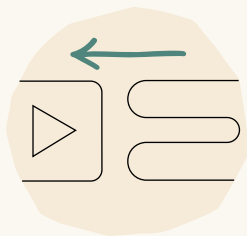
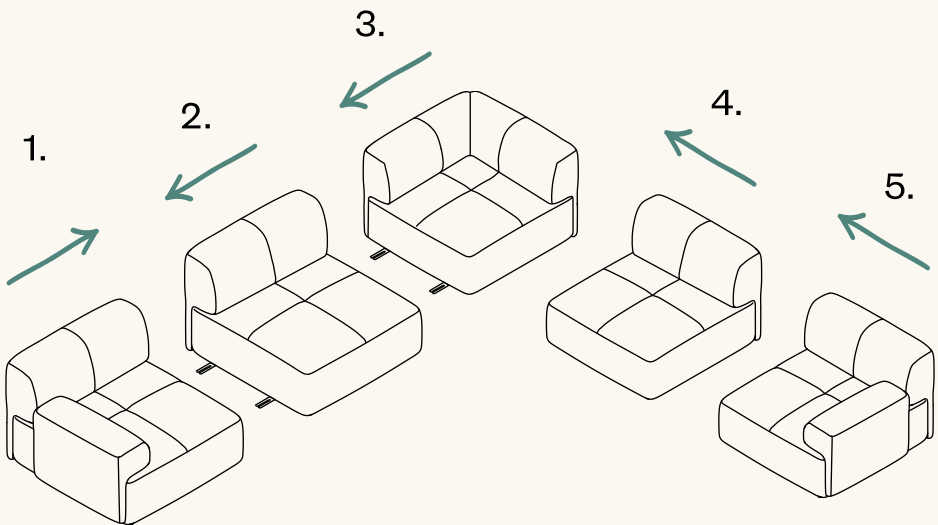

18.

Add your scatter cushions and enjoy!

