



# A guide to your Everyday Sofa

Life is better together.  
Please assemble with  
two people.



# What comes with your 4 seater with chaise

You should have 6 boxes in total.

## Low arm seat - 1 box

---

1x Low arm seat

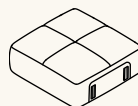

## Chaise seat box - 1 box

---

1x Chaise seat

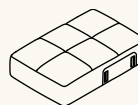

## Low arm and back box - 2 boxes

---

2x Low arms



2x Backs



2x Scatter cushions



# What comes with your 4 seater with chaise

## Armless seat box - 1 box

---

1x Armless seat

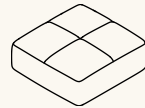

## Armless back box - 1 box

---

1x Back



1x Scatter cushion



First, let's assemble the low arm section.

Decide which side you'd like to have your chaise on.

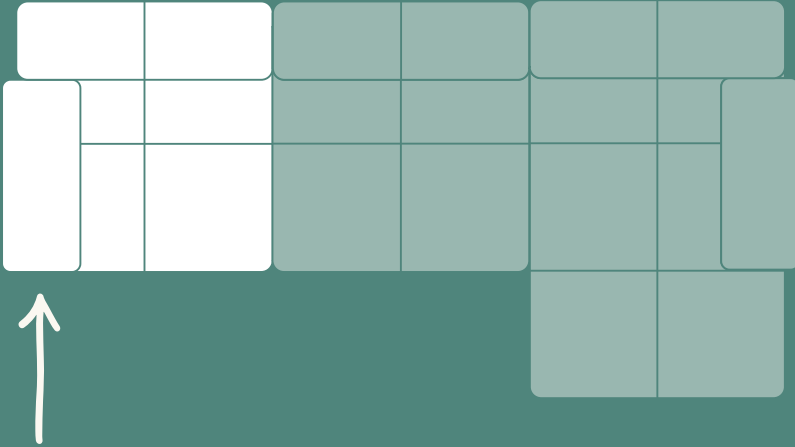

Place arm on left hand side.

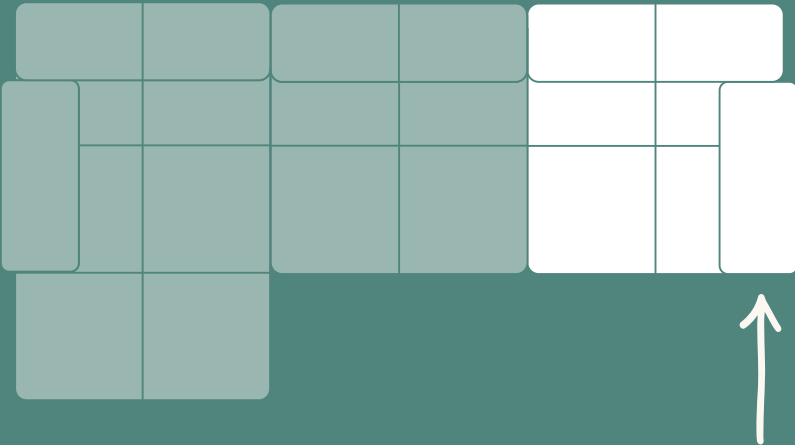

Place arm on right hand side.

# 1.

Turn seat up onto its side.

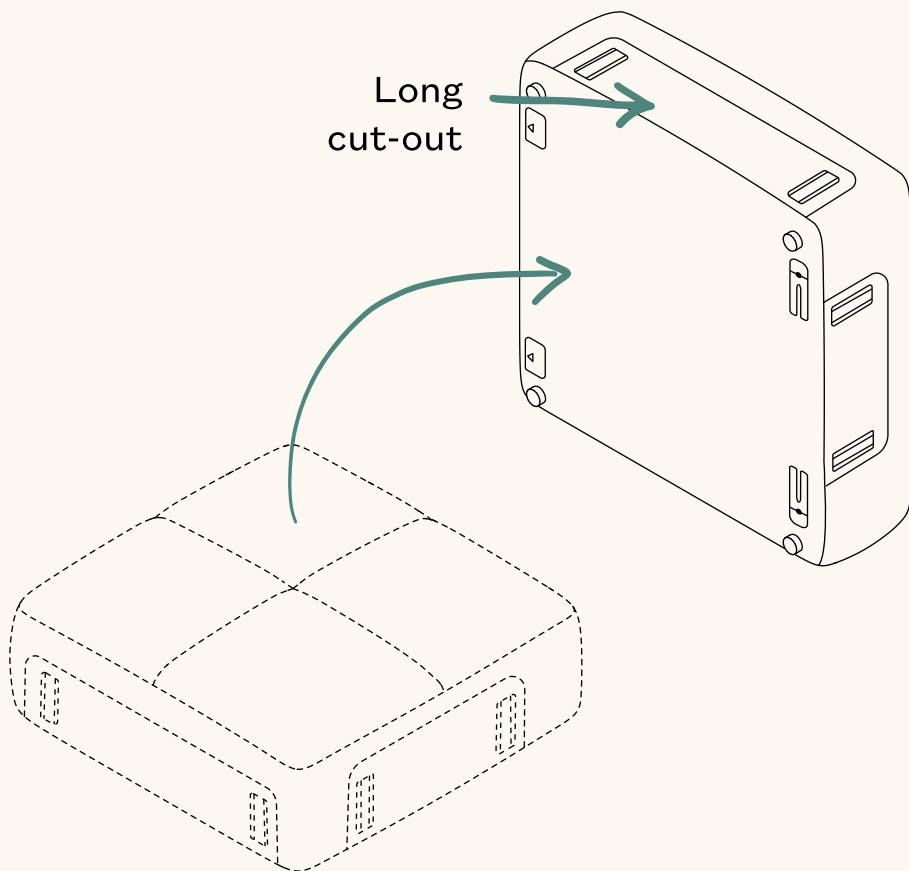

## 2.

Align brackets between the back and seat and slide back into place.

We recommend having one person slide the back piece on and the other holding the seat in place.

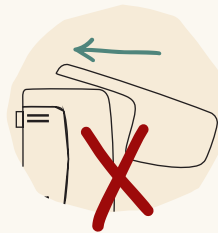
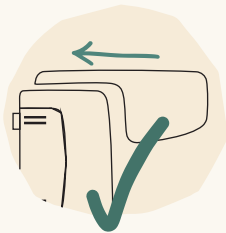
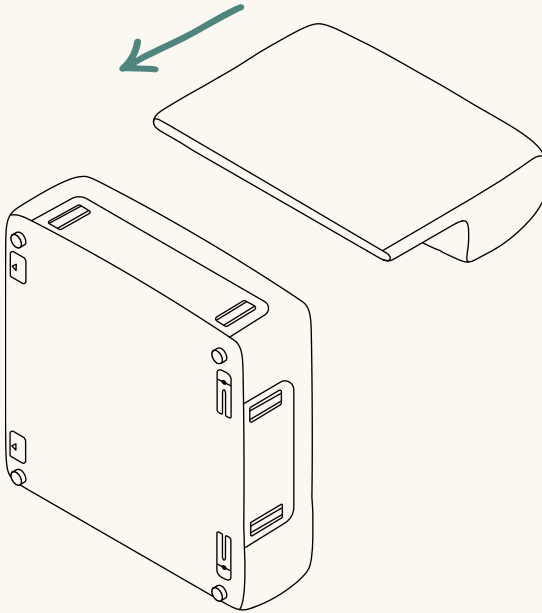

### 3.

Rotate 90 degrees and flip onto its side.

Arm brackets should be facing the ceiling on the side you would like the arms on.

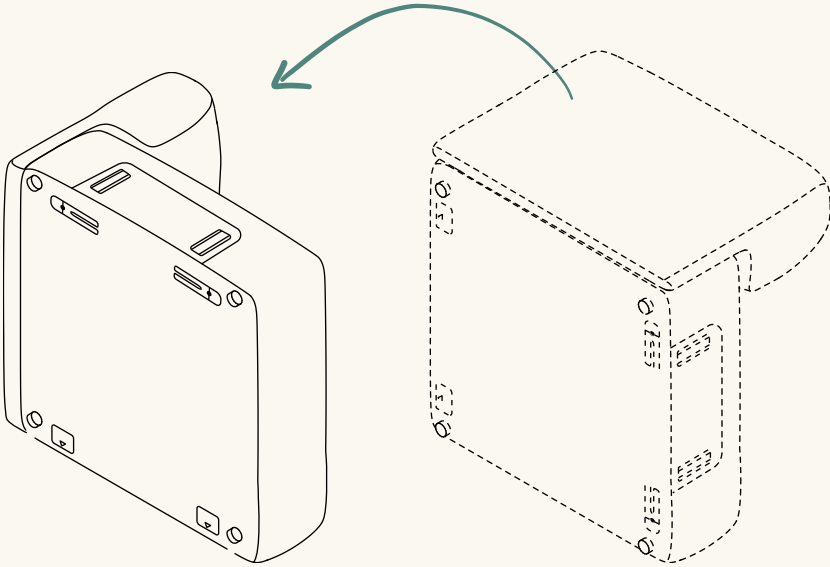



# 4.

Align brackets between the arm and seat and slide arm into place.

We recommend having one person slide the arm piece on and the other holding the seat in place.

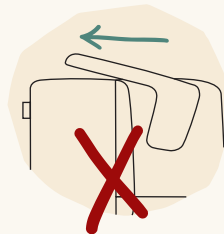
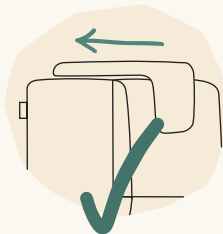
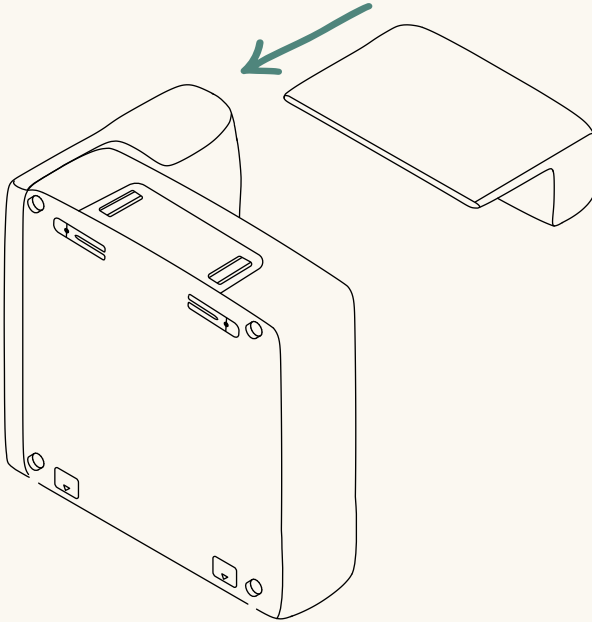

# 5.

This module is now assembled!  
Flip upright and set aside.

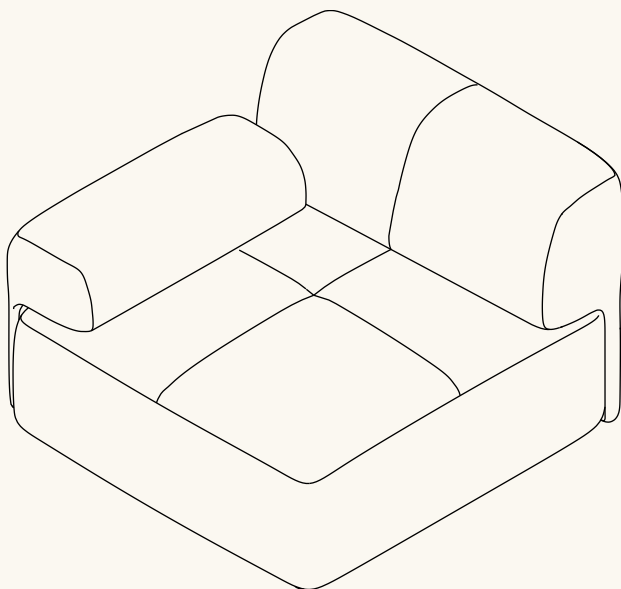

To assemble the chaise, repeat steps 1-4 but place the low arm on the opposite side.

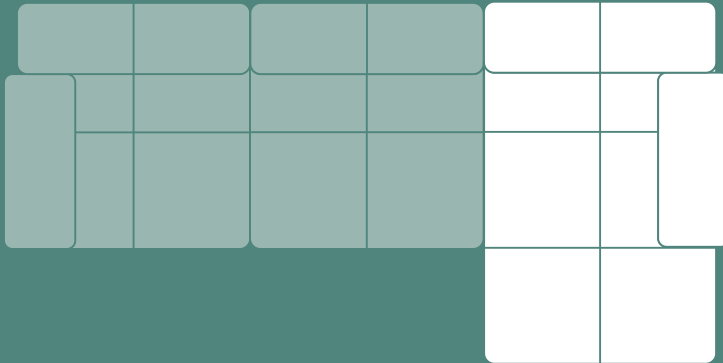

Place arm on  
right hand side.

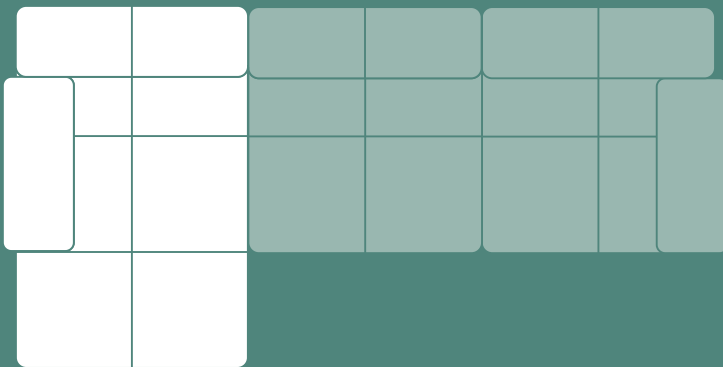

Place arm on  
left hand side.

# 6.

Rotate the brackets out.

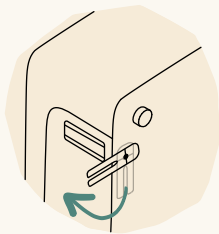
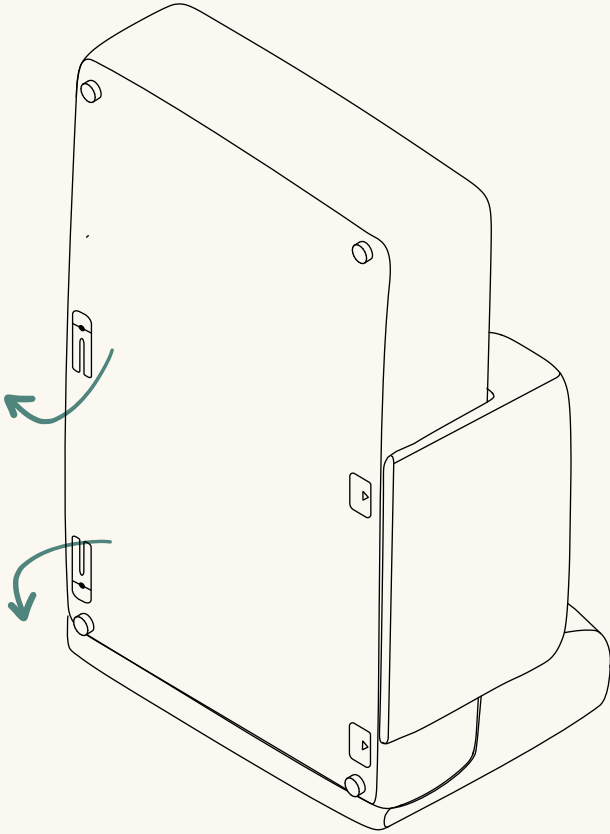

Now let's assemble the middle section.

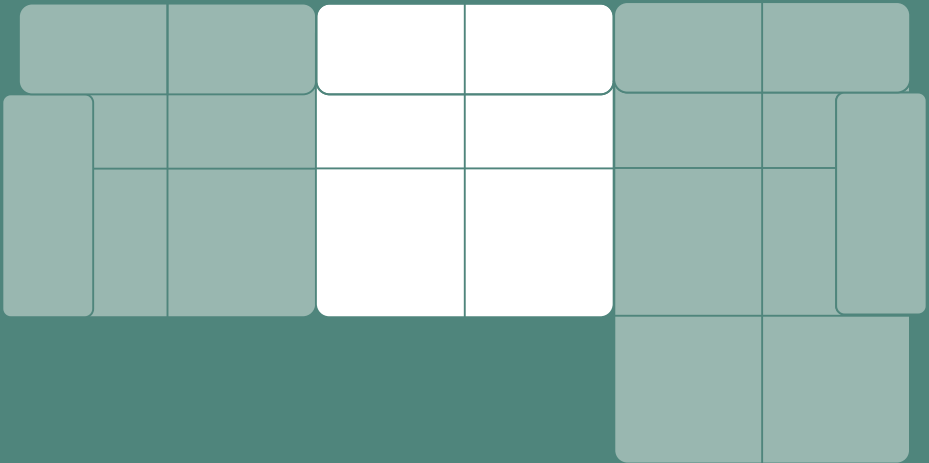

# 7.

Turn seat up onto its side.

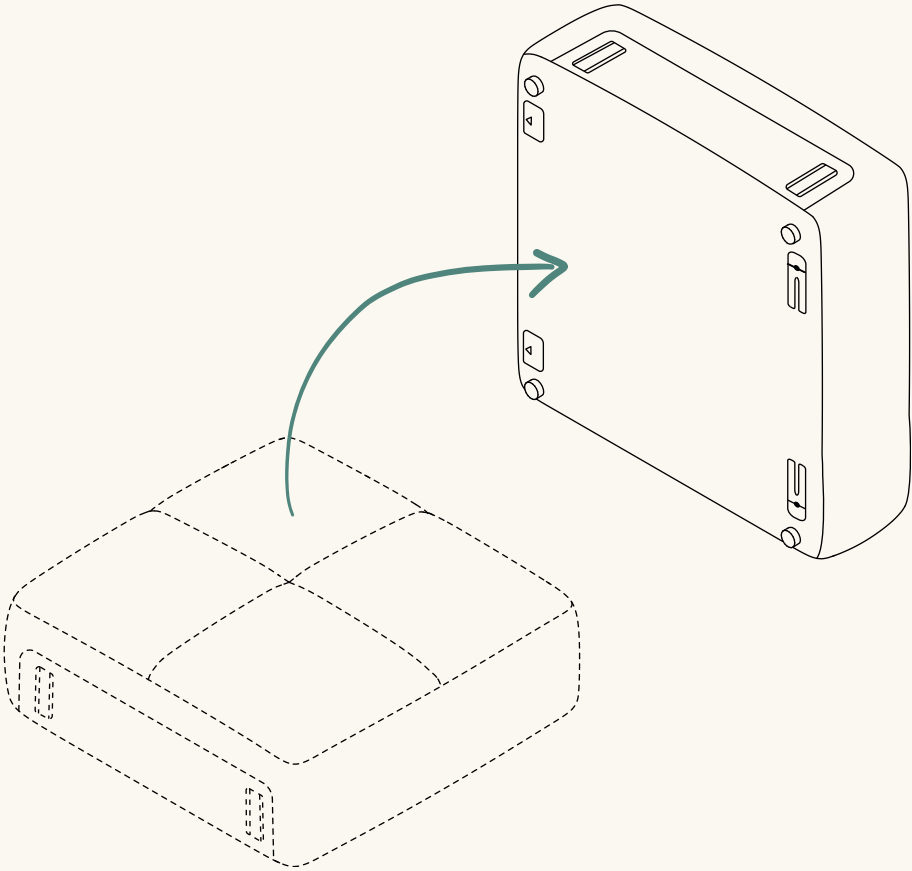

# 8.

Align brackets between the back and seat and slide back into place.

We recommend having one person slide the arm piece on and the other holding the seat in place.

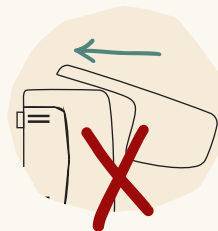
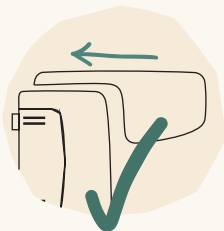
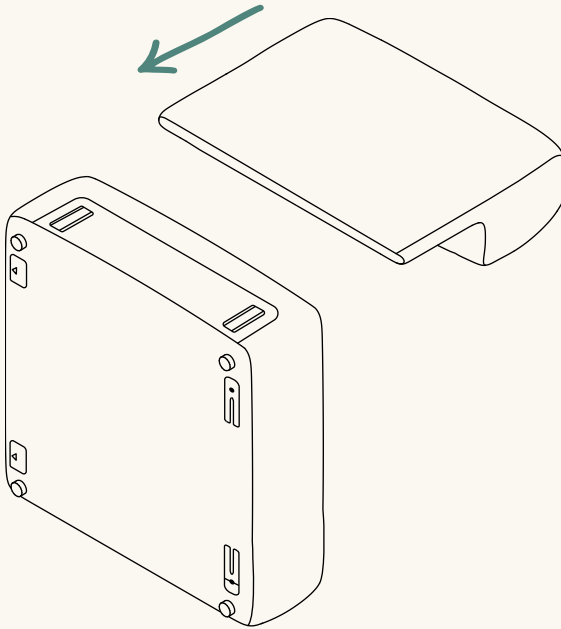

# 9.

Rotate the brackets out.

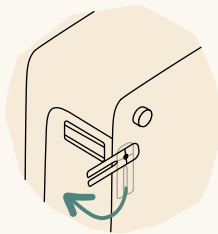
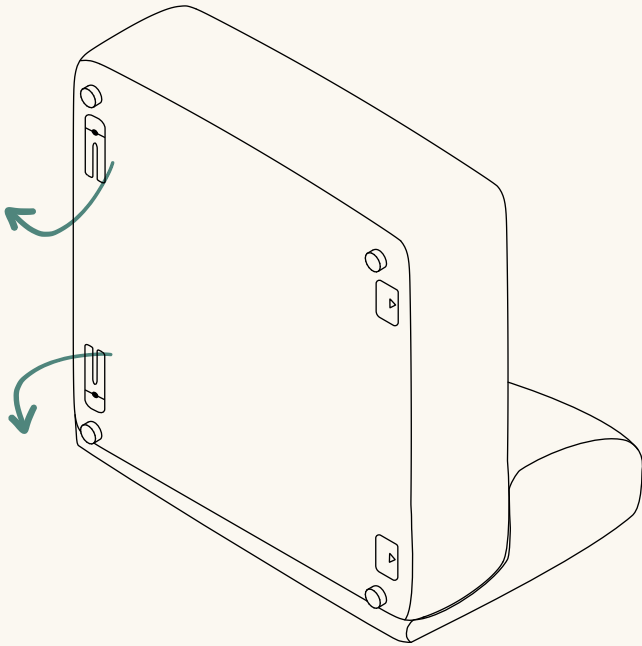



# 10.

This module is now assembled!  
Flip upright and set aside.

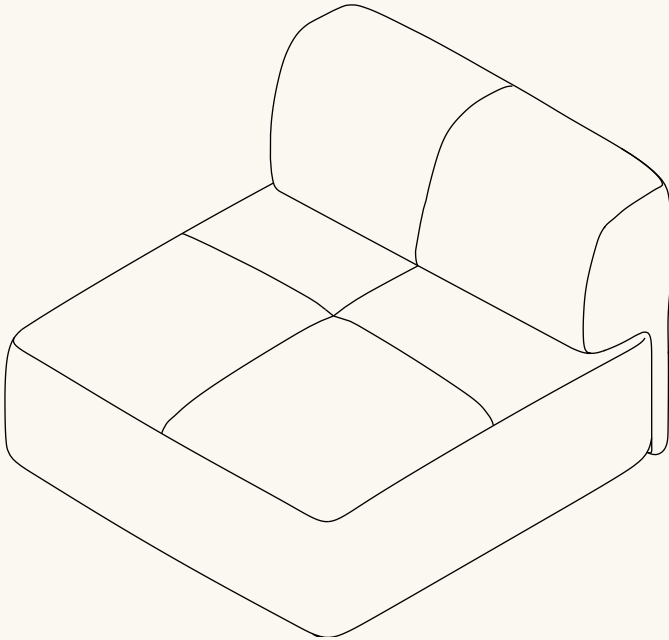

Choose where you would like your Everyday Sofa to live and then it's time to connect the modules together.

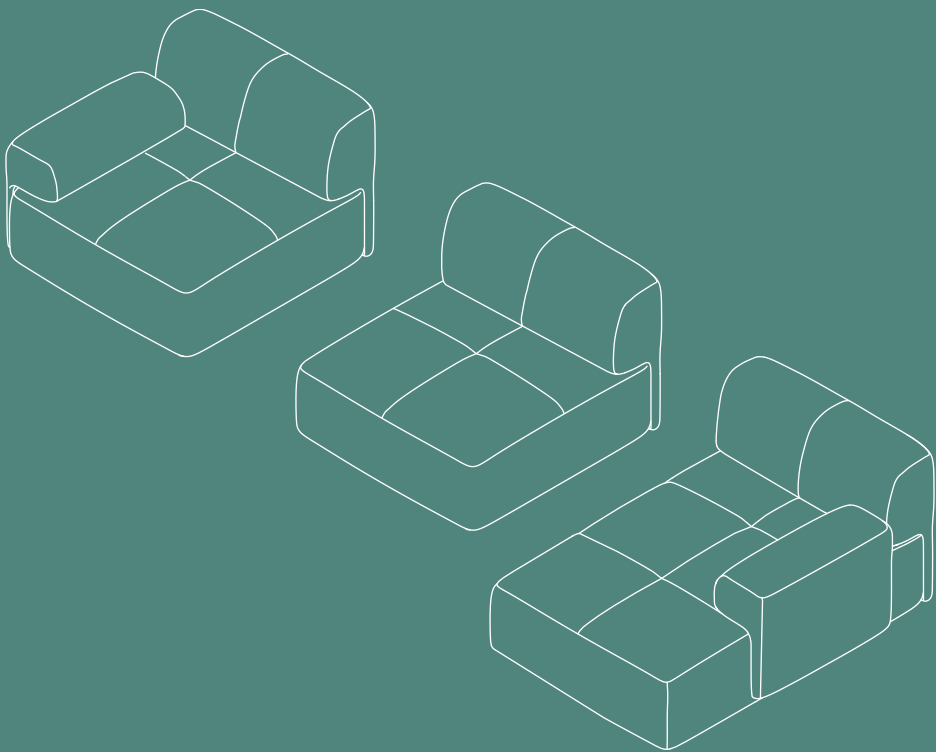

# 11.

Align connectors and push modules together.

These will click together and lock the pieces.

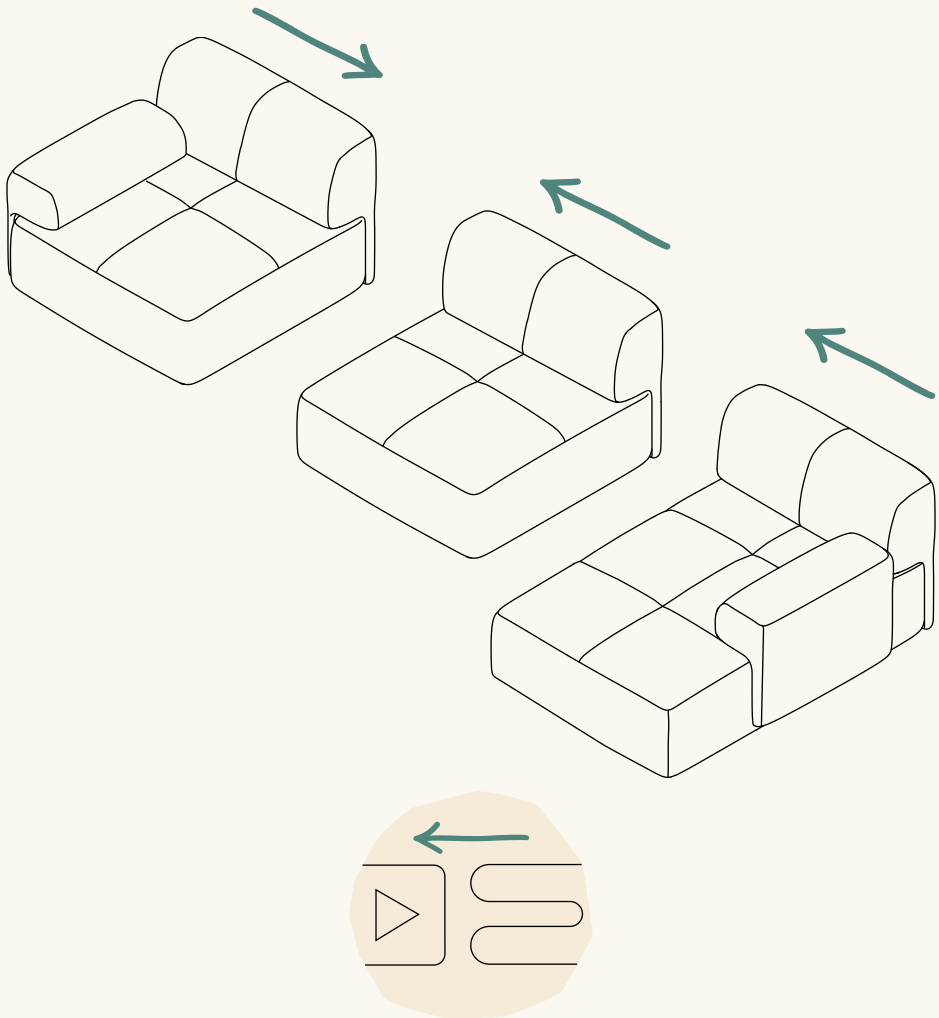

# 12.

Add your scatter cushions and enjoy!

