



# A guide to your Everyday Sofa

Life is better together.  
Please assemble with  
two people.



# What comes with your 4 seater

You should have 6 boxes in total.

## Low arm seat box - 2 boxes

---

2x Low arm seat

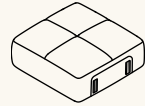

## Low arm and back - 2 boxes

---

2x Low arms



2x Backs



2x Scatter cushions



# What comes with your 4 seater

## Armless seat box - 1 box

---

1x Armless seat

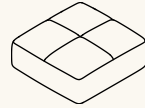

## Armless back box - 1 box

---

1x Back



1x Scatter cushion



First, let's assemble the low arm section.

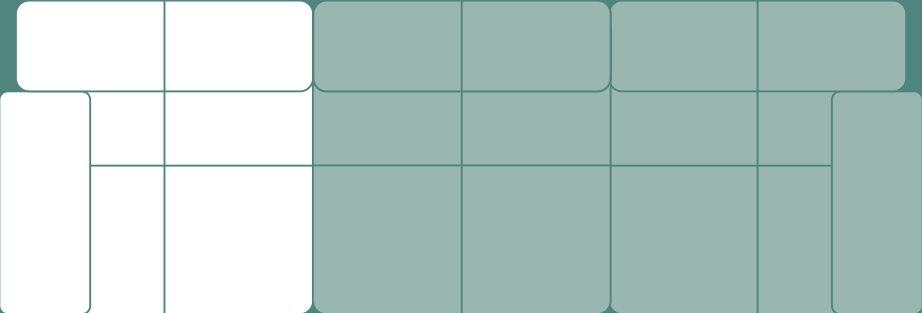

Place arm on  
left hand side.

# 1.

Turn seat up onto its side.

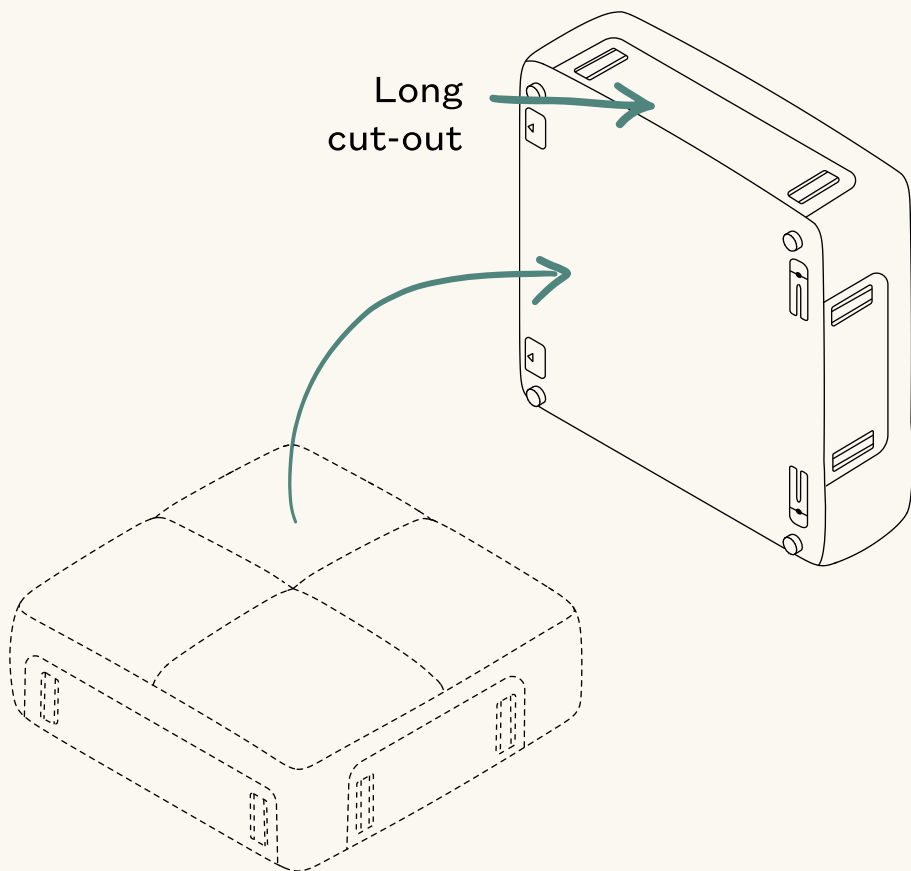

## 2.

Align brackets between the back and seat and slide back into place.

We recommend having one person slide the back piece on and the other holding the seat in place.

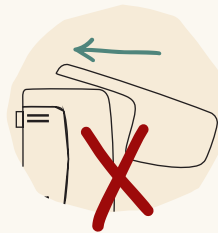
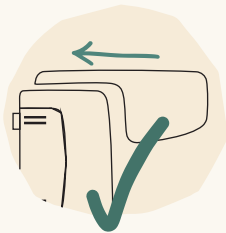
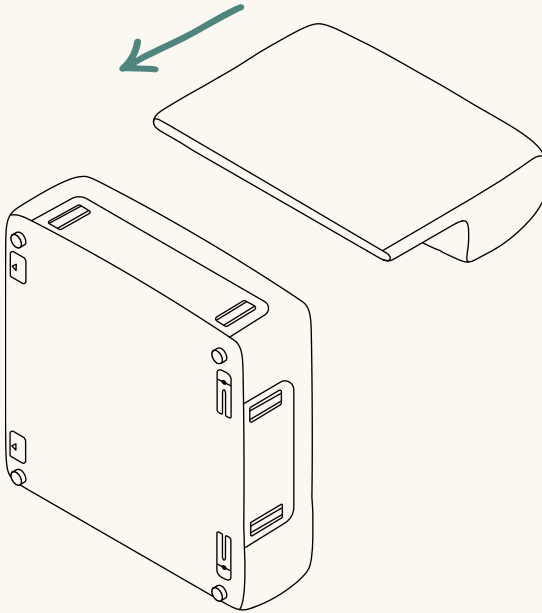

### 3.

Rotate 90 degrees and flip onto its side.

Arm brackets should be facing the ceiling on the side you would like the arms on.

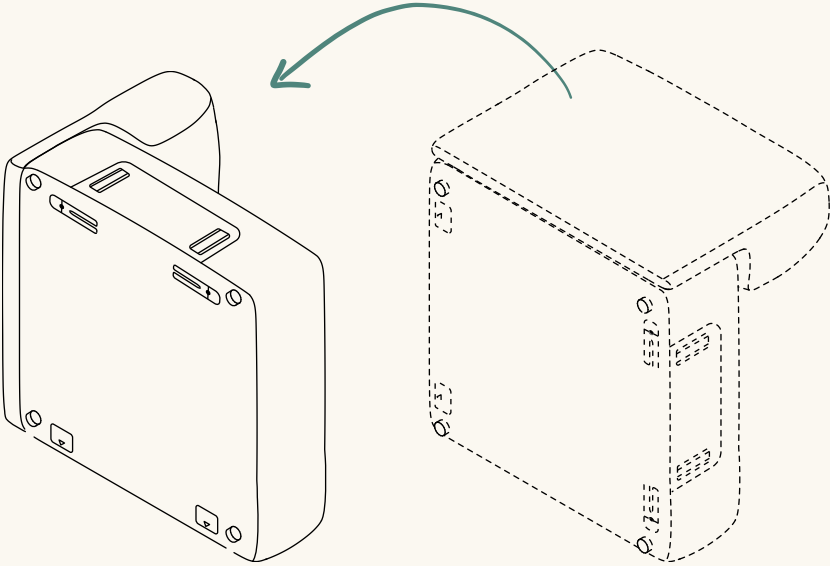



# 4.

Align brackets between the arm and seat and slide arm into place.

We recommend having one person slide the arm piece on and the other holding the seat in place.

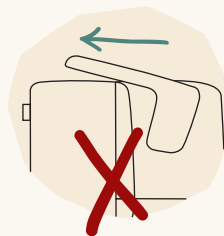
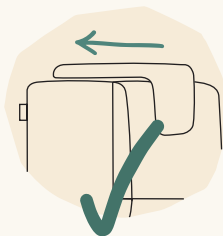
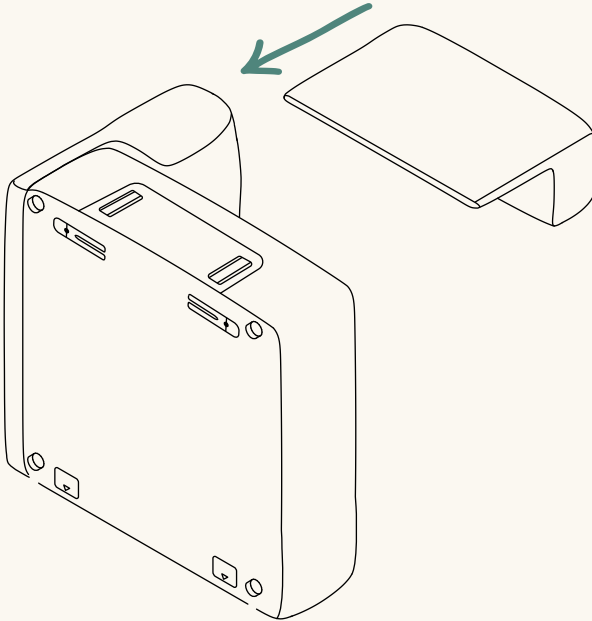

# 5.

This module is now assembled!  
Flip upright and set aside.

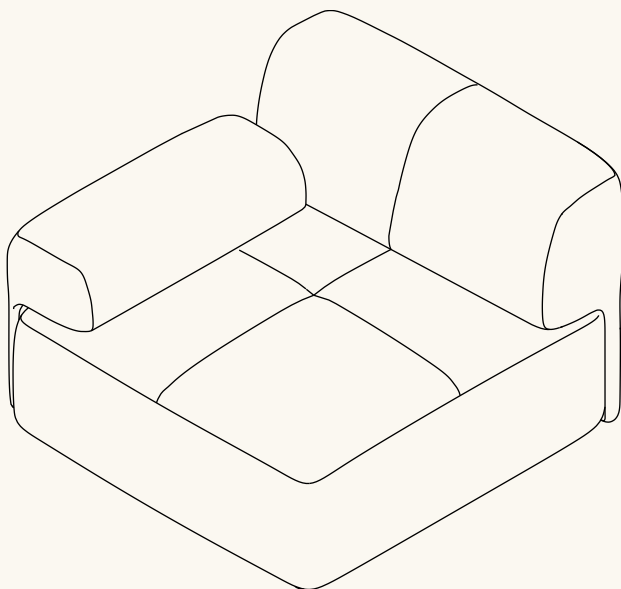

To assemble the right side,  
repeat steps 1-4 but place the  
low arm on the right side.

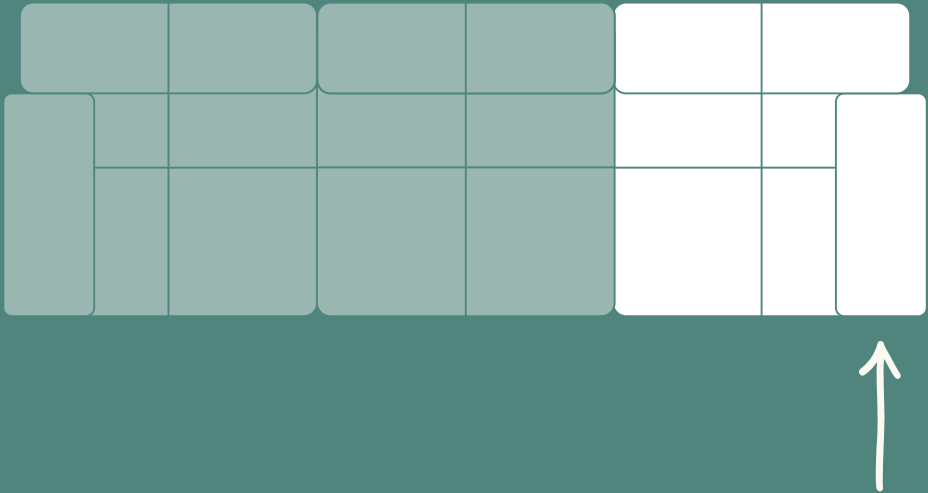

Place arm on  
right hand side.

# 6.

Rotate the brackets out.

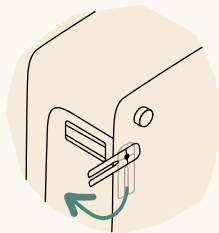
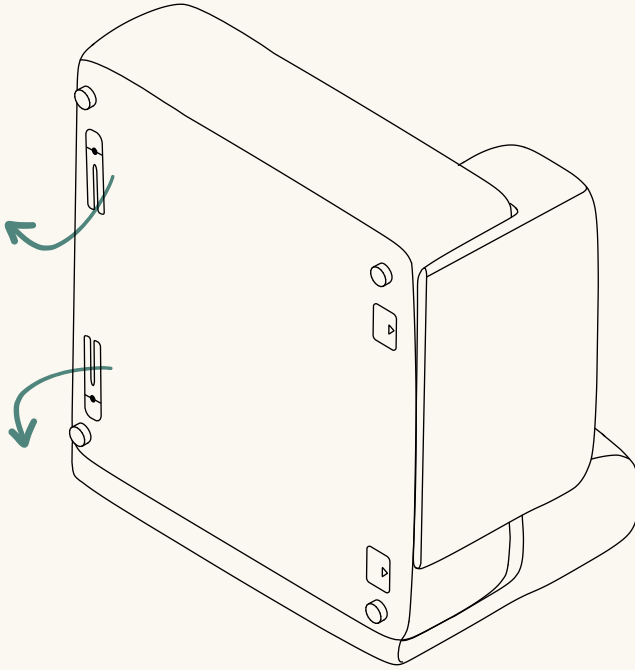

Now let's assemble the middle section.

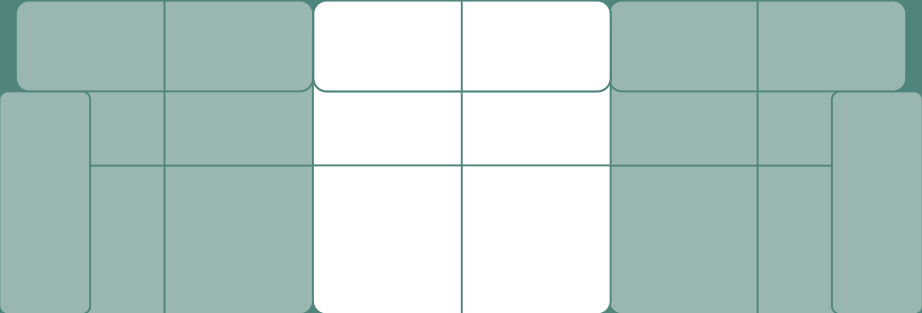

# 7.

Turn seat up onto its side.

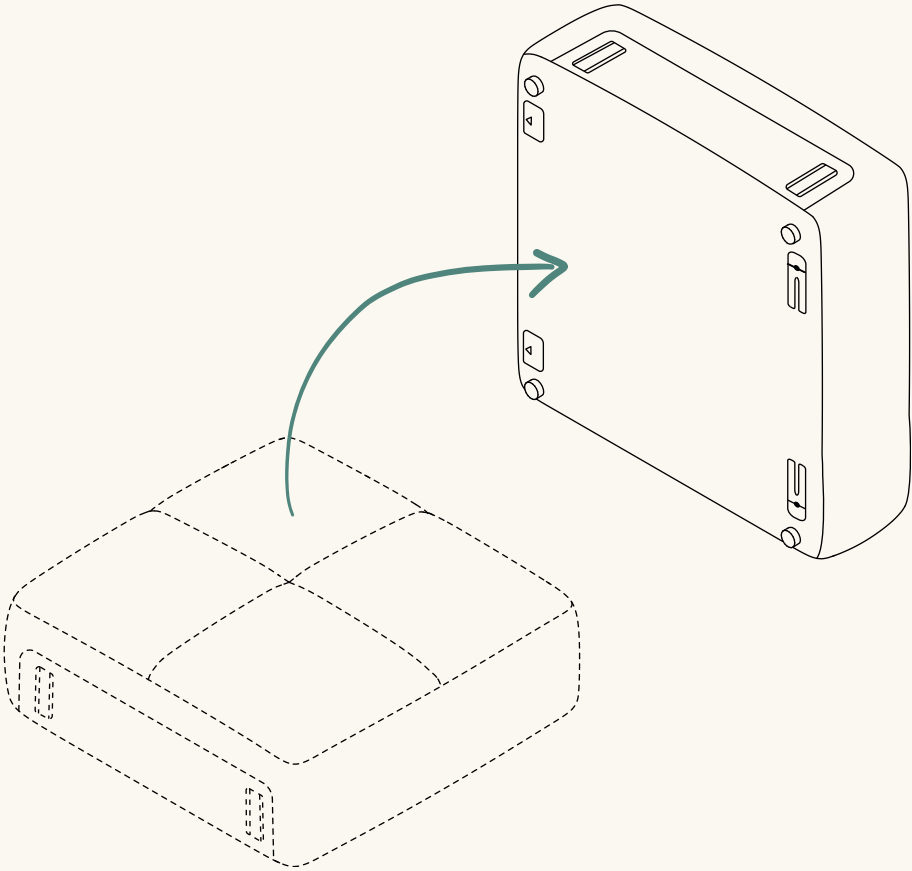

# 8.

Align brackets between the back and seat and slide back into place.

We recommend having one person slide the arm piece on and the other holding the seat in place.

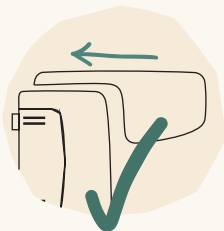
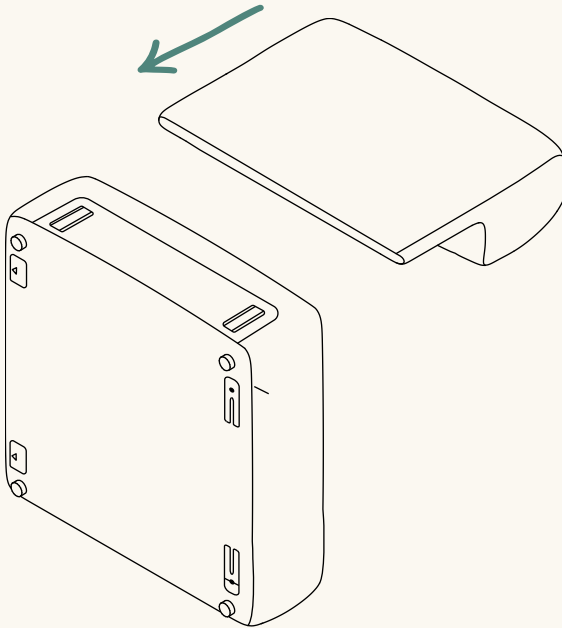

# 9.

Rotate the brackets out.

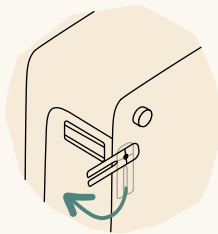
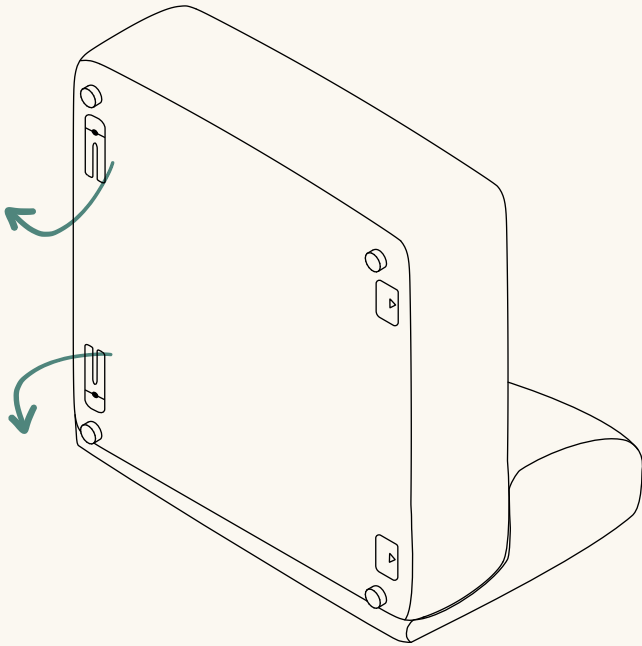



# 10.

This module is now assembled!  
Flip upright and set aside.

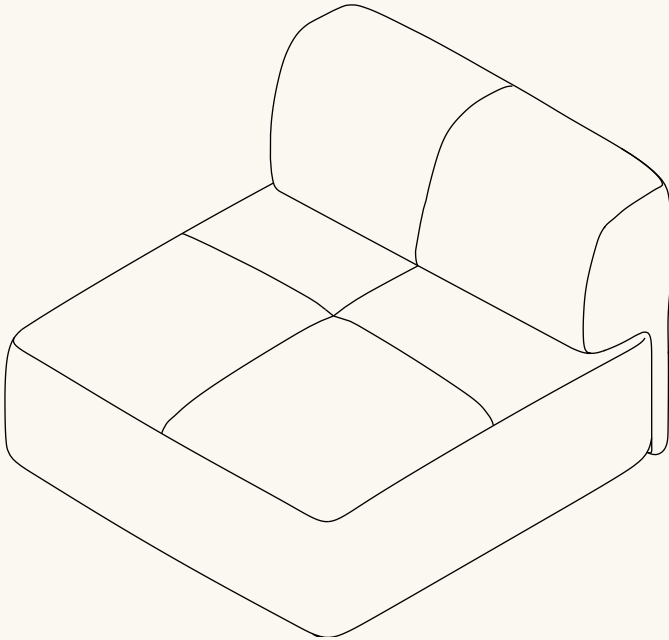

Choose where you would like your Everyday Sofa to live and then it's time to connect the modules together.

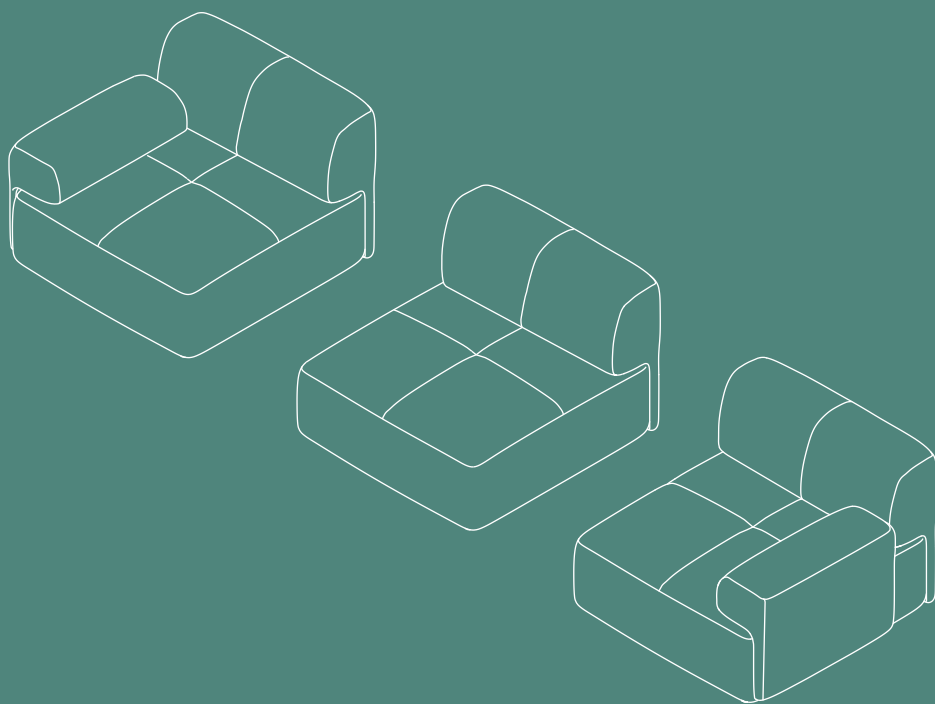

# 11.

Align connectors and push modules together.

These will click together and lock the pieces.

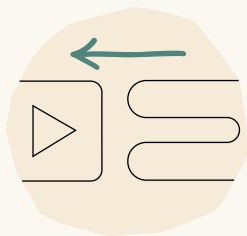
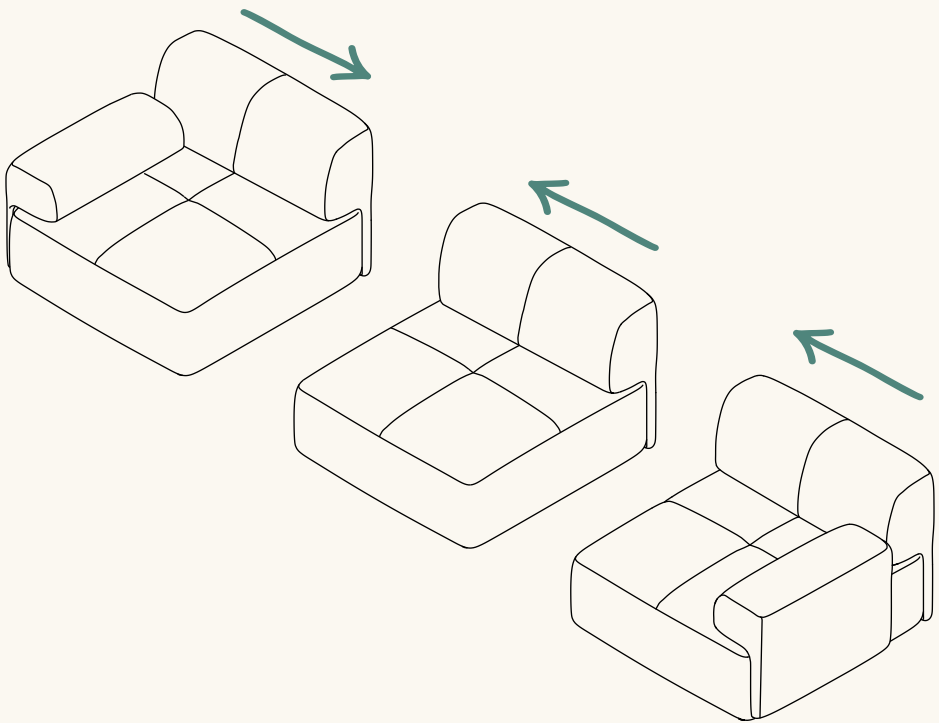

# 12.

Add your scatter cushions and enjoy!

